

# TFR4SQLite Railroad Diagram

## TableDefinition:

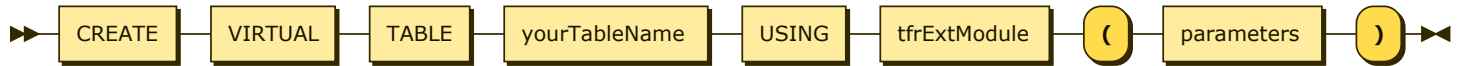

## tfrExtModule:

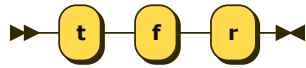

## parameters:

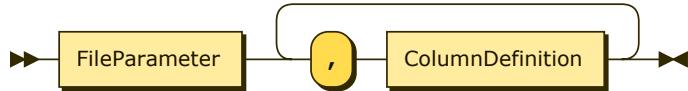

## FileParameter:

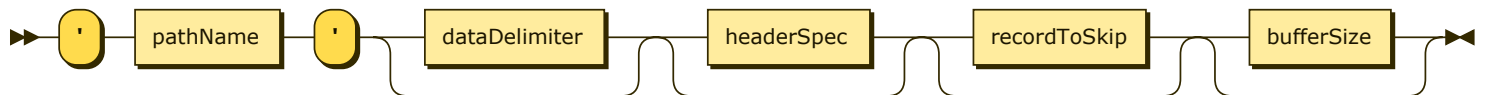

## dataDelimiter:



## recordDelimiter:

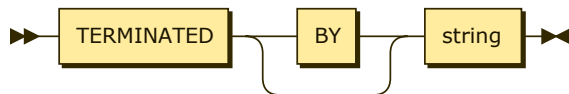

## headerSpec:

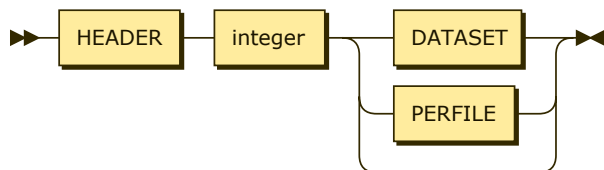

## recordToSkip:

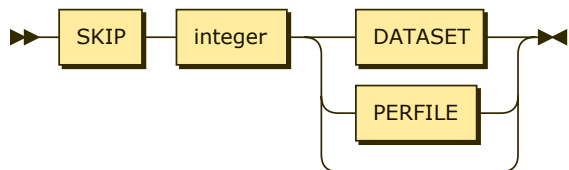

## bufferSize:

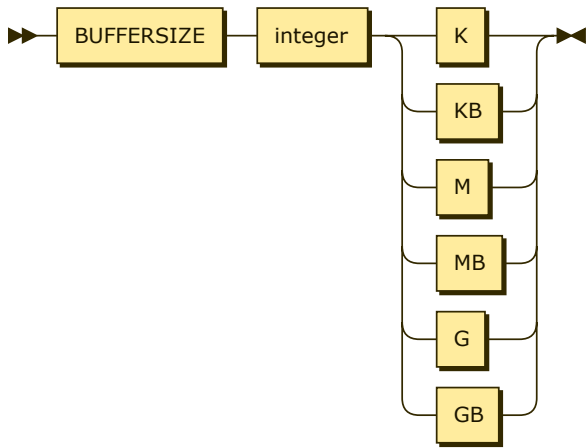

**ColumnDefinition:**

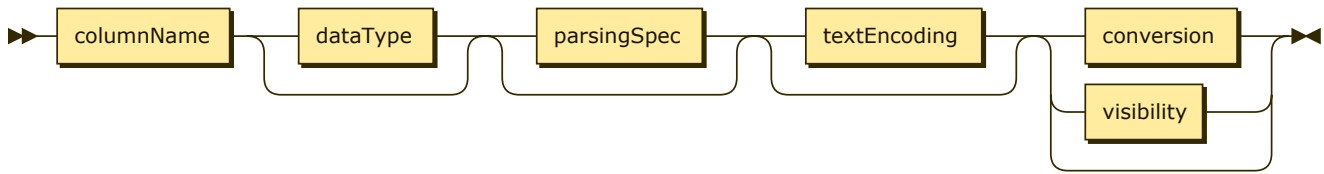

**dataType:**

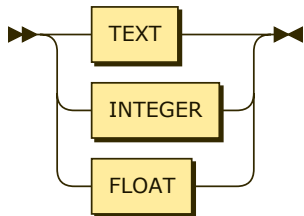

**parsingSpec:**

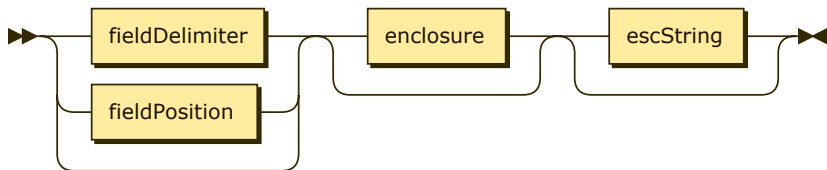

**fieldDelimiter:**

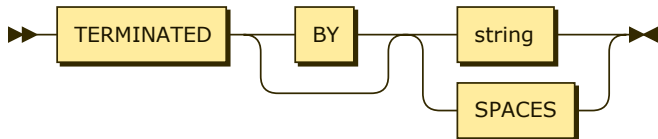

**fieldPosition:**

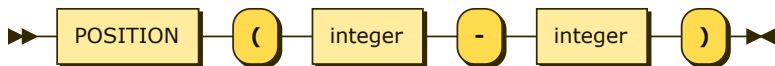

**enclosure:**

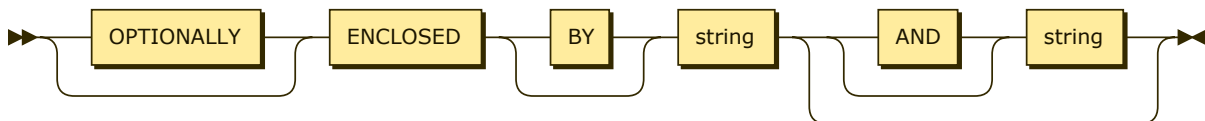

**escString:**

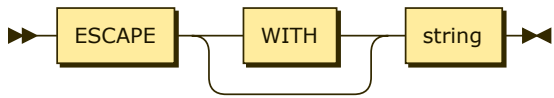

**textEncoding:**

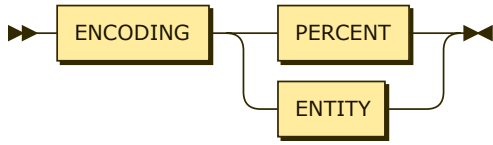

**conversion:**

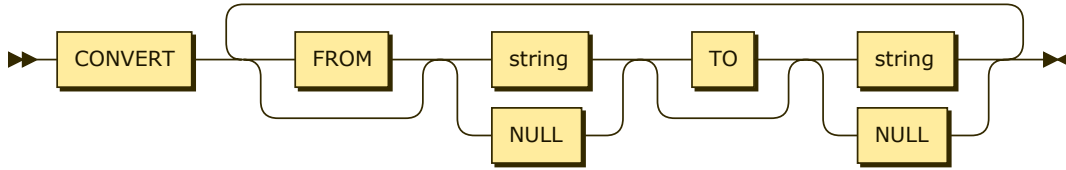

**visibility:**

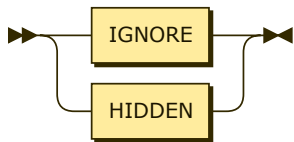

**integer:**

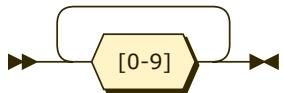

**string:**



**yourTableName:**



**columnName:**



**nameLiteral:**

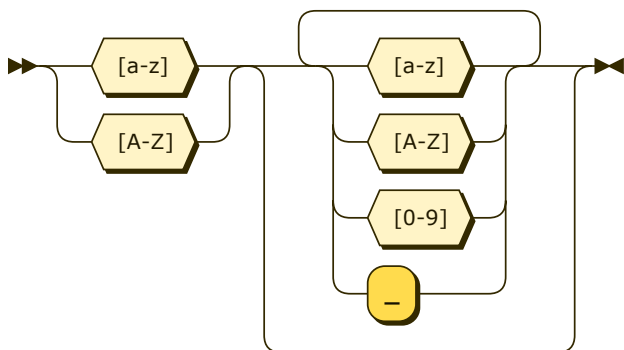

**pathName:**



**pathLiteral:**

